

ASSEMBLY INSTRUCTION

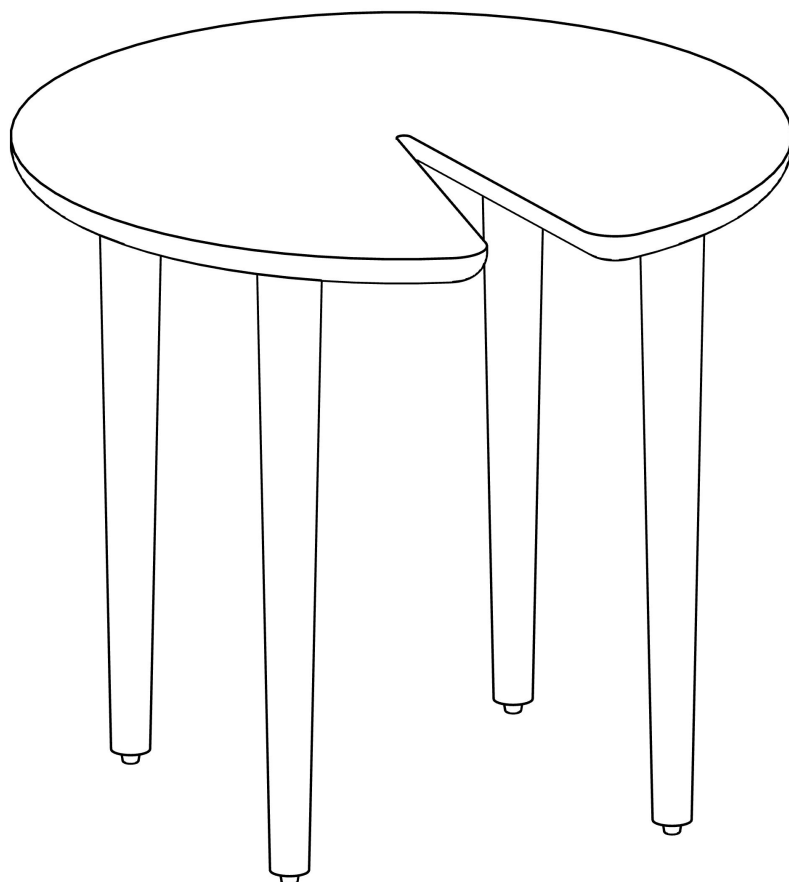

Lilypad Coffee Table

PRODUCT CODE: HOCTA00116
HOCTA00017/18

ASSEMBLY RATING

The Assembly Rating is a 5-point system that shows the degree of effort needed in assembling a specific product (with 1 being easy and 5 being difficult).

For most products, two persons are recommended.

EASY ●●○○○ DIFFICULT

Requirement for Assembly

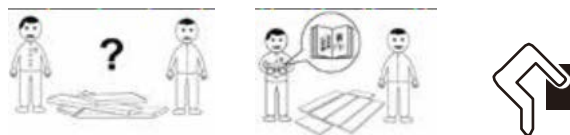
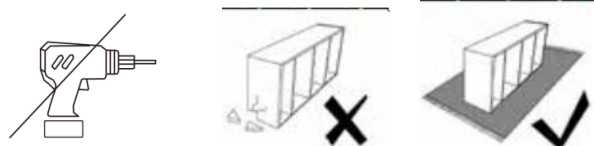

2 PERSONS RECOMMENDED

HARDWARE DETAIL

ASSEMBLED PRODUCT

HARDWARE

QTY.

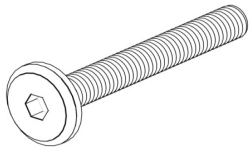

Allen Bolt
M8x20mm

8 pcs

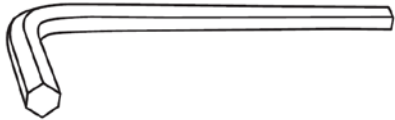

Allen key No. 5

1 pcs

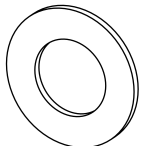

Spring Washer
8.5mm

8 pcs

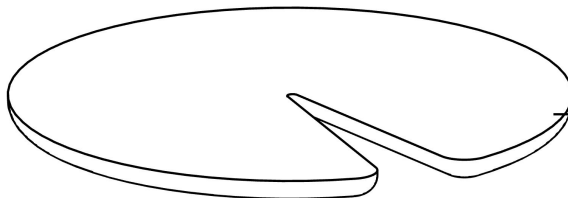
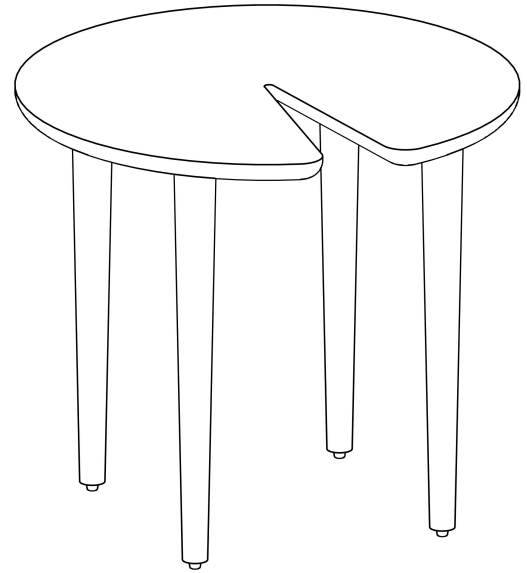

→ Part-A(1 pcs)

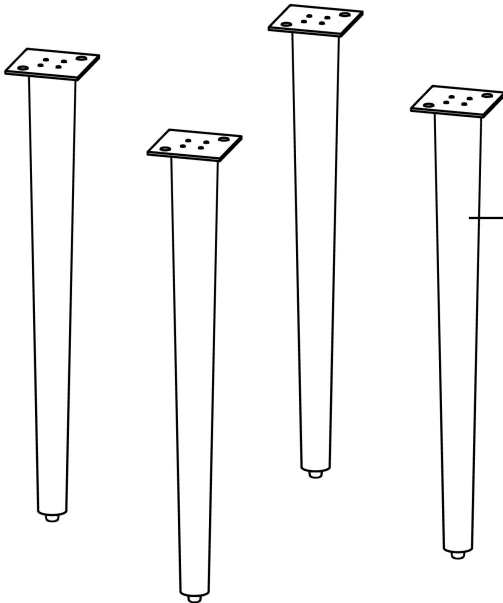

→ Part-B(4 pcs)

STEP01

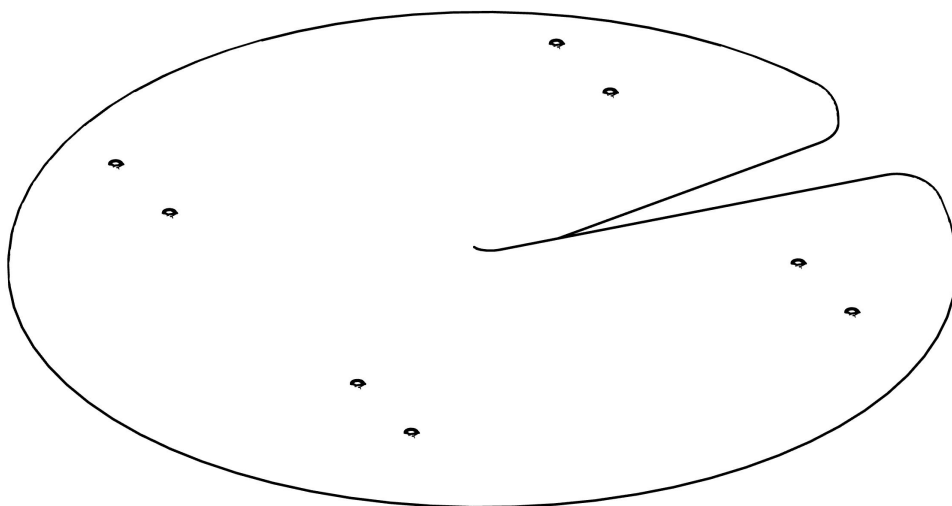

Flip the Part- A on carpet as shown in fig.

STEP02

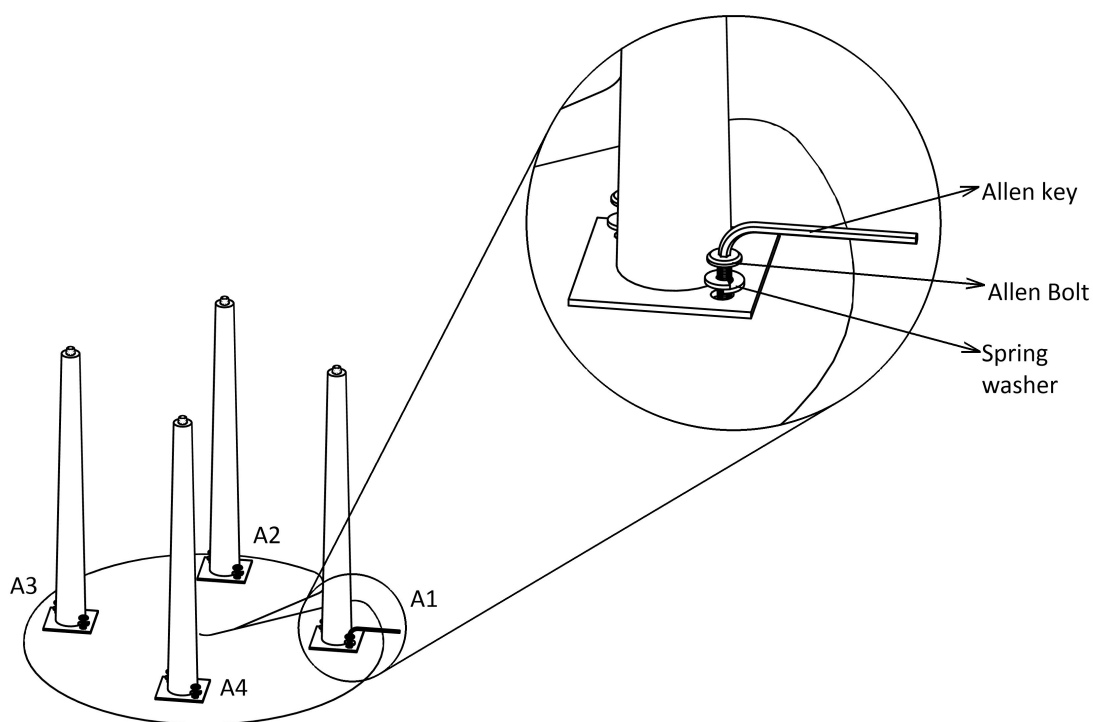

Fix the Part-B and Part -A with washer and allen bolt of M8x20 mm using Allen key at position A1,A2,A3 and A4 as shown in fig.

STEP03

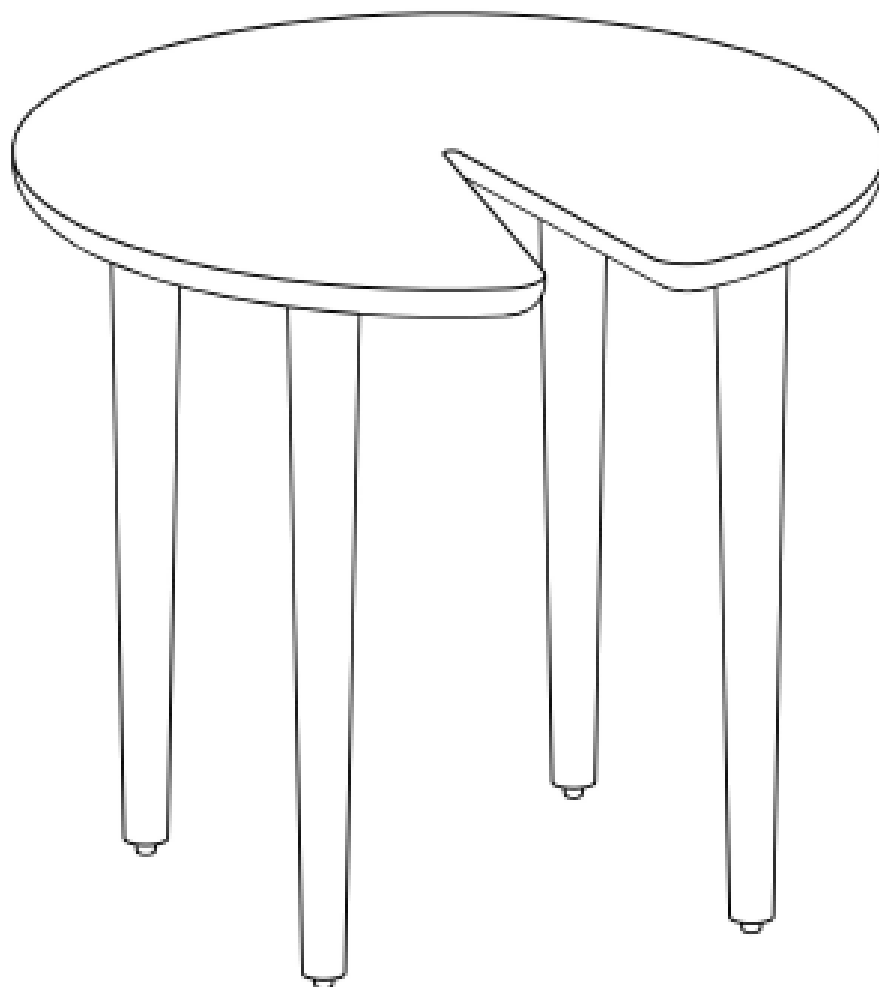

Flip the table and your table is ready to use.

Thank you for your purchase!

We hope you will enjoy your new product for many years to come. Our commitment to providing quality products does not simply end when a purchase is made. We stand behind our products and will provide any support needed in order for you to fully enjoy your purchase. Your satisfaction is the greatest recognition we could have.

Because we value your trust in our company, we will do our best to meet your service expectations. Should you have any assembly related questions, parts replacement requests, comments or suggestions, please feel free to contact us any time. To help expedite the service, please have the assembly instructions available, along with your order receipt.

Note :

Do not dispose of any packaging or contents of the shipping carton until assembly is completed to avoid accidentally discarding small parts or hardware.

CARE INSTRUCTIONS

Clean

Dust off with a soft, dry cloth and vacuum your upholstery regularly

For wiping, use a mild cleansing agent. On surfaces, do not use harsh agents which contain ammonia or bleach.

Don't forget to give your cushions a good shake every week or so to help them keep their shape.

For a full cleanse of upholstered furniture, we recommend professional cleaning by a certified company that can come to your home.

If your design has removable covers you can take it along to your local dry cleaner.

Stains

Take care of spills immediately. Absorb the spill with a clean white cloth or paper towel.

Gently dab the surface and lift the stains.

For linen and cotton-blend fabrics that are more heavily dyed, bear in mind that spot cleaning may lift the dye leaving a lighter patch.

In the case of fabrics such as Velvet, be sure to never scrub the fabric harshly. Velvet, is very sensitive to liquids and should be kept dry at all times. It should be professionally dry-cleaned only.

If you spill on a Leatherette surface, the best thing to do is wipe up the spill immediately using a damp cotton or wool cloth and then dry using a clean soft cloth.

In some cases you may not be able to remove a stain by simply wiping the leatherette with warm water. In these cases you will need to use a soap and water mixture. In a small bowl, combine warm water with a tablespoon of mild dish soap or hand soap and wipe the stained area with a soft cotton cloth using the soap mixture.

After you have wiped the entire surface with soapy water, take a new cloth and dip it in a bowl of plain water. This will help to rinse away any soap that remains on the leatherette. Once the leatherette has been rinsed, use a clean dry cloth to dry the surface. Dab the cloth over the entire surface until it is completely dry.

Note : You can use a cotton-swab to clean hard-to-reach areas instead of a dry cloth.

Avoid

Keep the furniture away from direct sunlight and away from heat sources; excessive exposure to sunlight may fade the colour of the upholstery.

Avoid placing heavy or sharp objects on the furniture surface for long periods of time; this can cause permanent indentations on the fabric.

To protect furniture from moisture, avoid placing the furniture in direct contact with damp walls. In case of contact, wipe the furniture promptly with a dry, soft and lint-free cloth.

Dragging the furniture over a prolonged period of time can weaken the joints. Always lift and place furniture pieces while repositioning.

To avoid surface damage always use a coaster and mats while placing hot, cold or wet materials on the furniture.

Avoid using furniture polish, chemical solvents and